

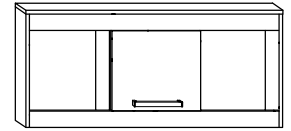

MXS-21

PÓŁKA 1D

→ 110 × 50 × 25



x 13



(a)

x 18



(b)

x 3



(c)

x 21



(d)

x 3 kpl.

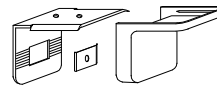

(e)

x 2

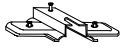

(f)

x 2

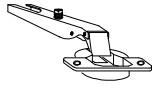

(g)

x 1

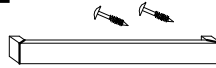

(h)

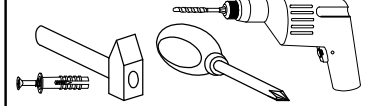

x 4

(3,5x16)



(i)

x 6

(6,2x13)



(j)

x 50

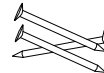

(k)

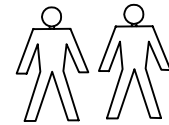

30 min



1 - FAZY MONTAŻU

A - OZNACZENIE ELEMENTÓW

a - OZNACZENIE AKCESORIÓW

1

x 6



(a)

x 6



(b)

x 3



(c)

x 1



(e)

x 2

(6,2x13)



(j)

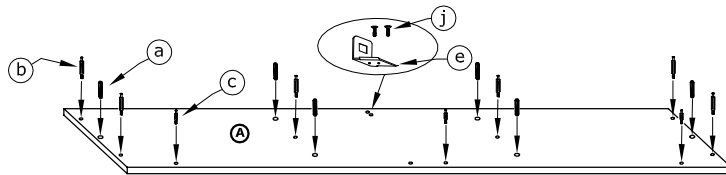

2

x 2



(a)

x 8



(b)

x 2



(e)

x 4

(6,2x13)



(j)

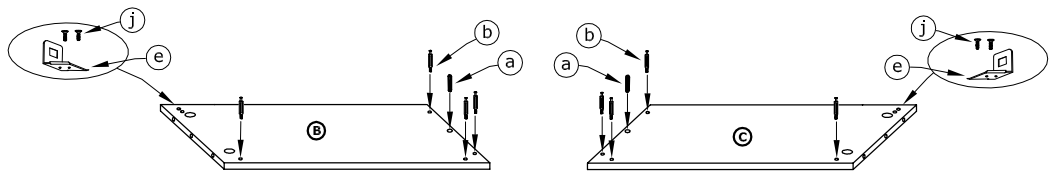

3

x 2



(f)

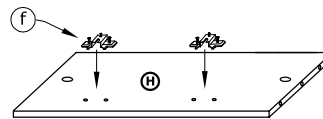

4

x 5



(a)

x 4



(b)

x 2



(d)

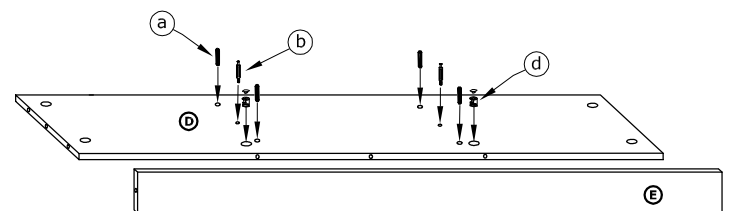
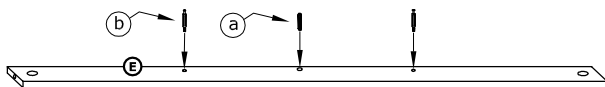

5

x 10
d

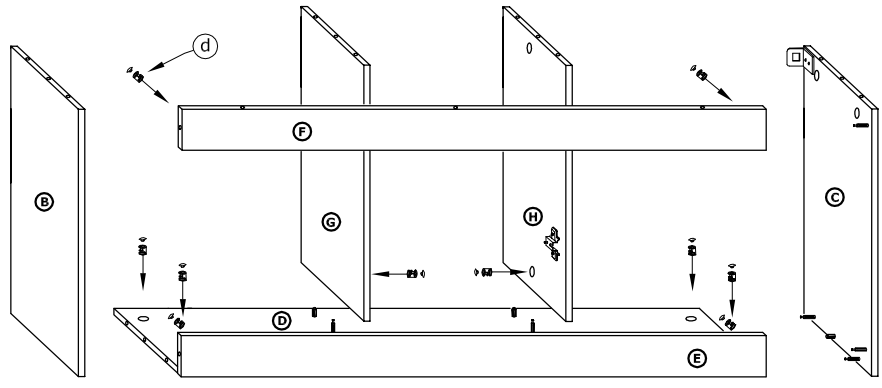

6

x 9
d

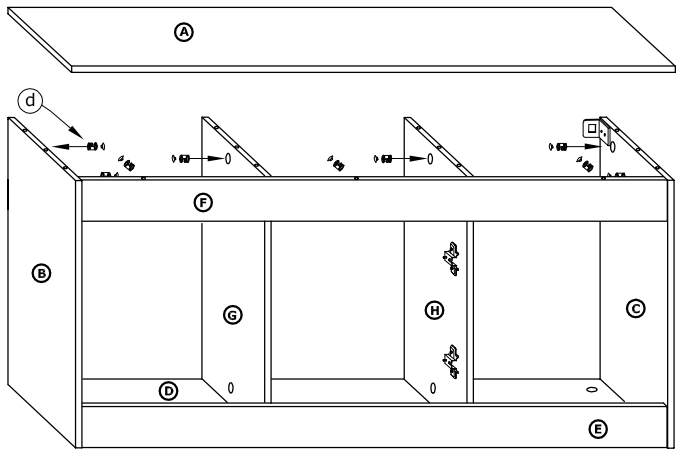

7

x 2 g	x 1 h	x 4 (3,5x16) i	x 50 k
----------	----------	----------------------	-----------

