















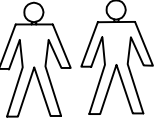
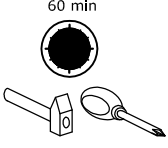
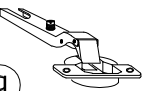
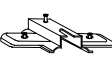

# MXS-26 REGAŁ N2D2S

→ 100 + 121 + 36

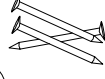

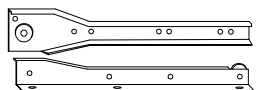
x 7  <b>(a)</b>	x 18  <b>(b)</b>	x 3  <b>(c)</b>	x 21  <b>(d)</b>	x 8  <b>(e)</b>	x 4  <b>(f)</b>	  60 min			
x 4  <b>(g)</b>	x 4  <b>(h)</b>	x 5  <b>(i)</b>	x 3  <b>(j)</b>	x 4  <b>(k)</b>	x 38 (3,5x16)  <b>(l)</b>		x 10 (3,5x30)  <b>(m)</b>	x 70  <b>(n)</b>	x 1  <b>(o)</b>
x 6  <b>(p)</b>	x 2 kpl. (300 mm)  <b>(r)</b>								

**1** - FAZY MONTAŻU

**A** - OZNACZENIE ELEMENTÓW

**a** - OZNACZENIE AKCESORIÓW

**1**

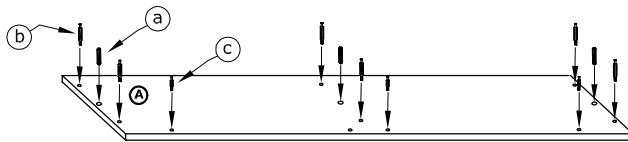
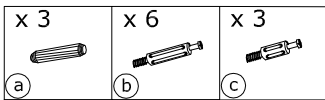

**2**

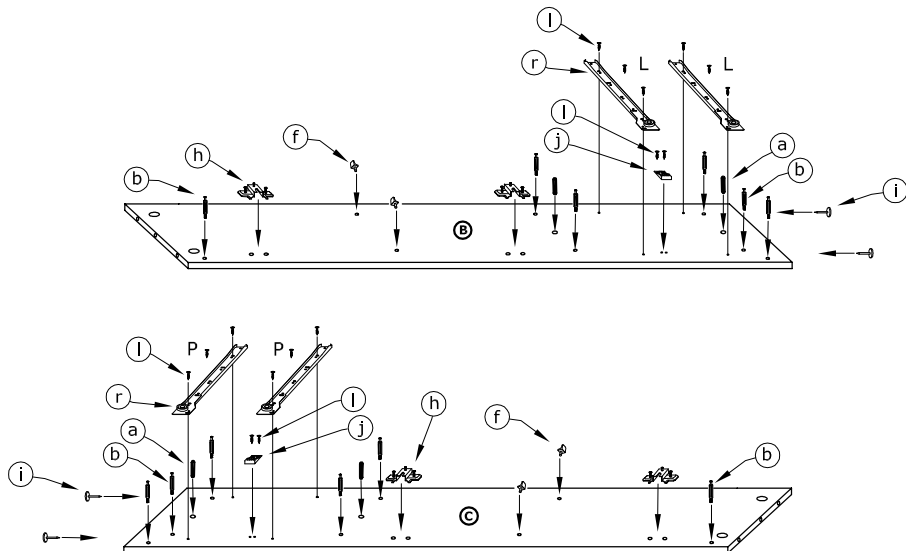
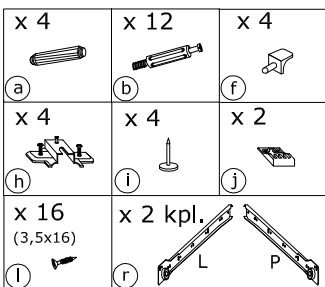

**3**

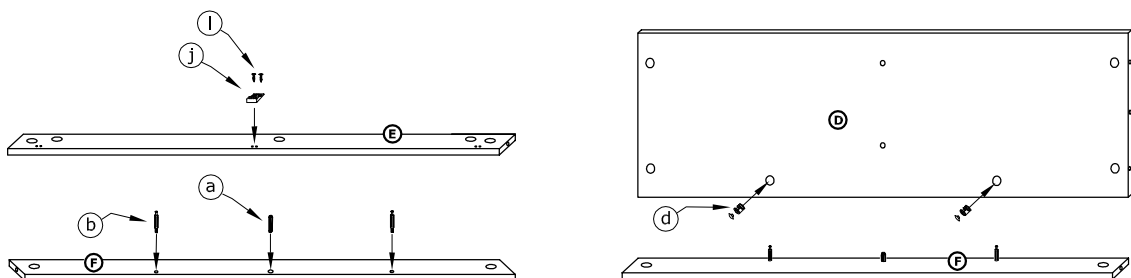
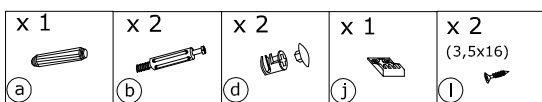

4

x 12



d

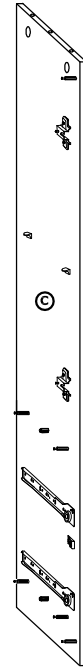
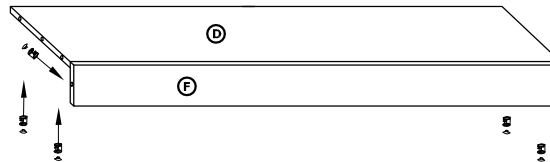
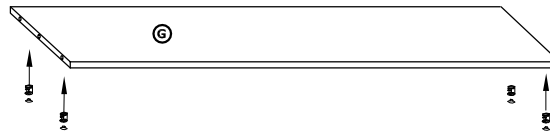
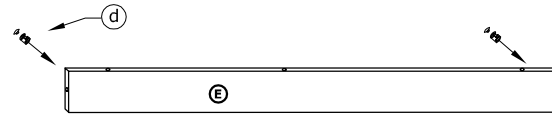
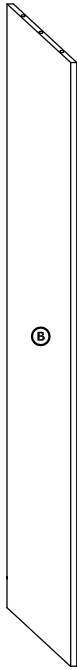

5

x 7

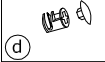

d

x 1





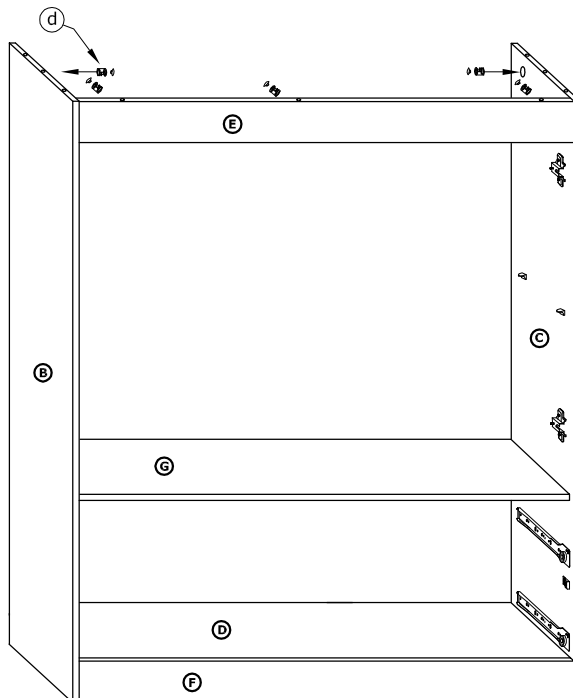
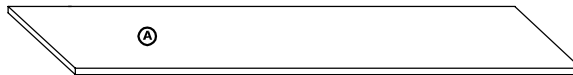



i

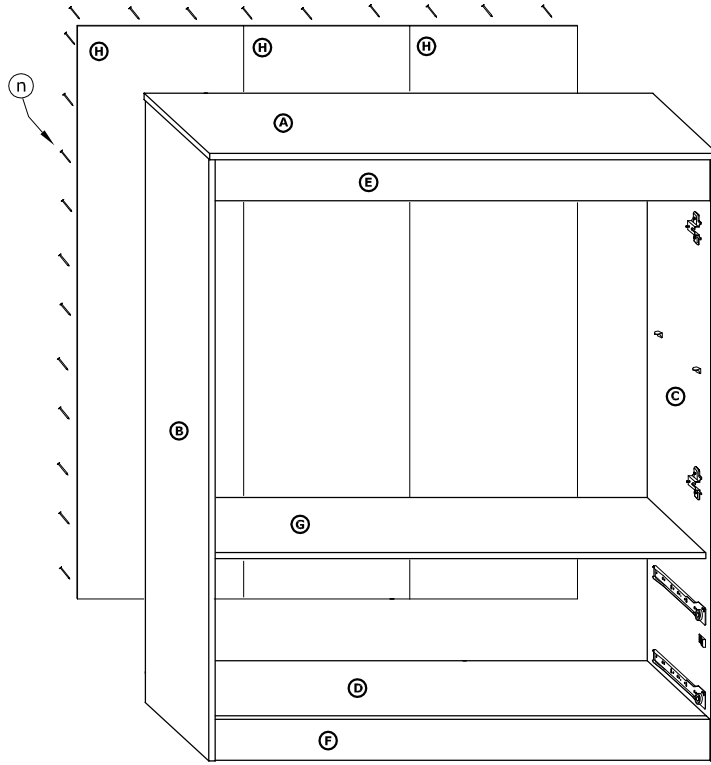



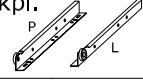

**6**

x 40  

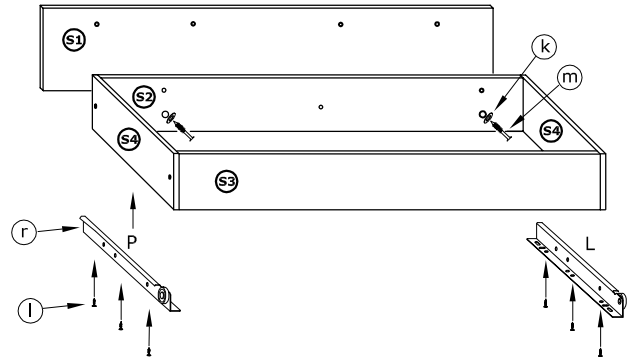
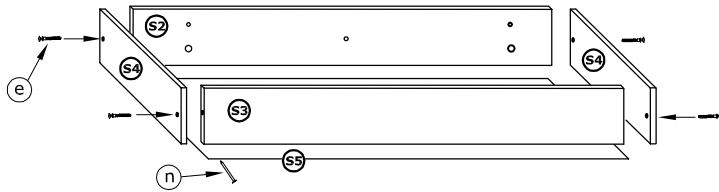
**7**

x 8  x 4  x 12 (3,5x16)  x 4 (3,5x30)  x 30  x 2 kpl. 

**X 2****X 2****8**

x 4  x 8 (3,5x16)  x 6 (3,5x30)  x 6 