

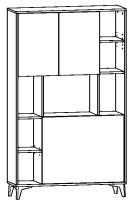











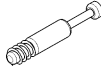

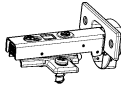
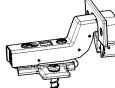

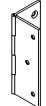
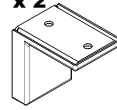
MEGAN 2

L-105 H-175 D-34/95



| | | | | | |
|--|--|--|--|--|---|
| x 16  AKC00019 | x 16  AKC00120 | x 16  AKC00004 | x 20  AKC00029 | x 20  AKC00151 | x 20  AKC00004 |
| x 4  ZAW00025 | x 2  ZAW00026 | x 20  AKC00023 | x 1  NOG00031 | x 2  ZAW00014 | x 2  AKC00066 |
| x 60  AKC00018 | x 24  3,5x16 AKC00026 | x 24  4x25 AKC00026 | x 4  AKC00031 | x 1  AKC00017 | x 2 N-120  MEC00453 |
| x 4  NOG00041 | | | | | |



⌚ 60 min

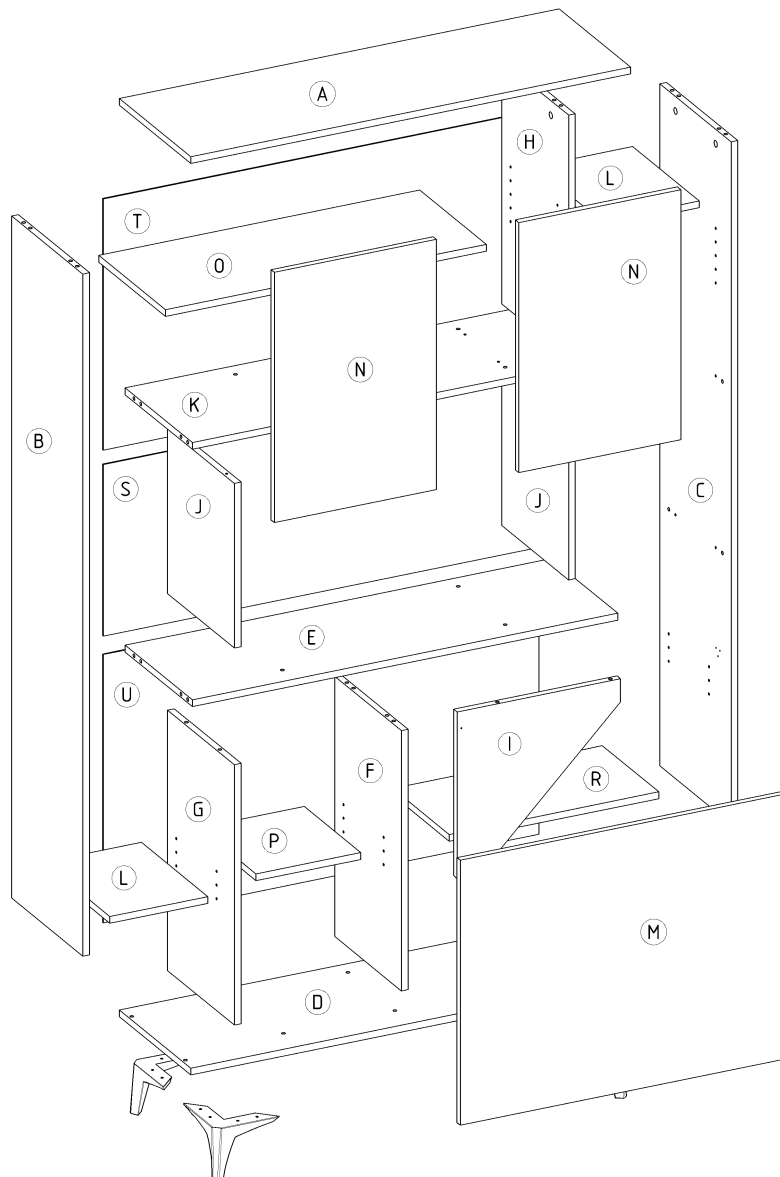

1

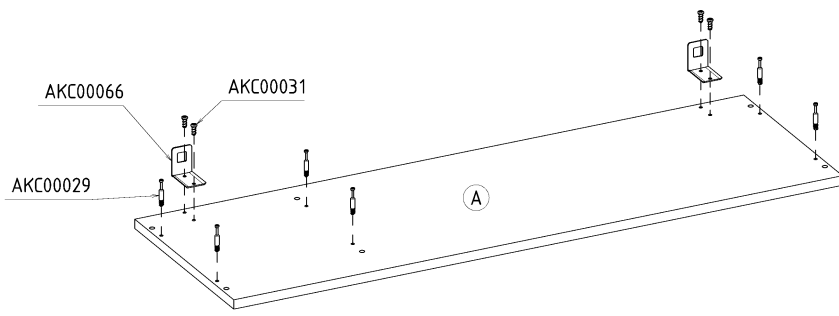

2

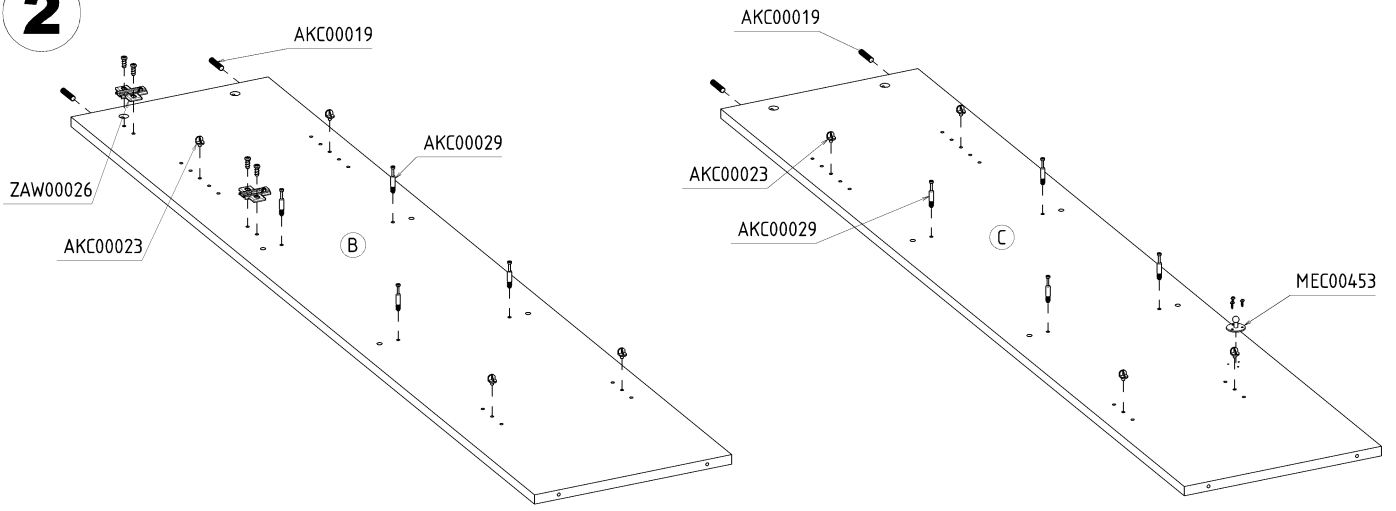

3

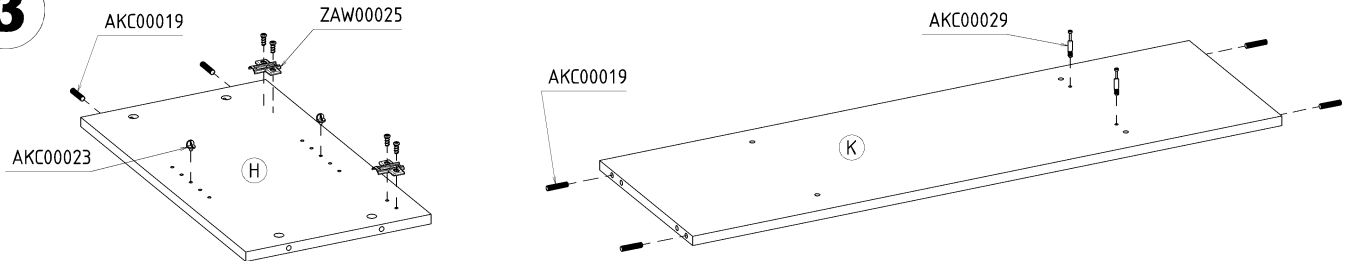

4

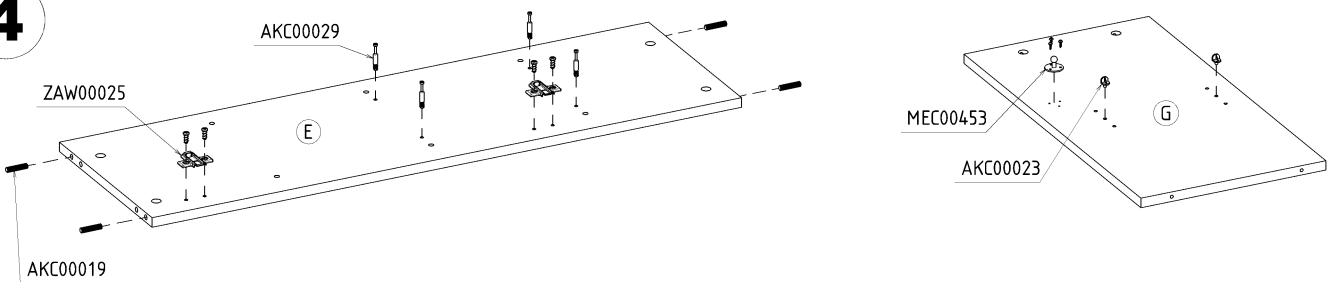

5

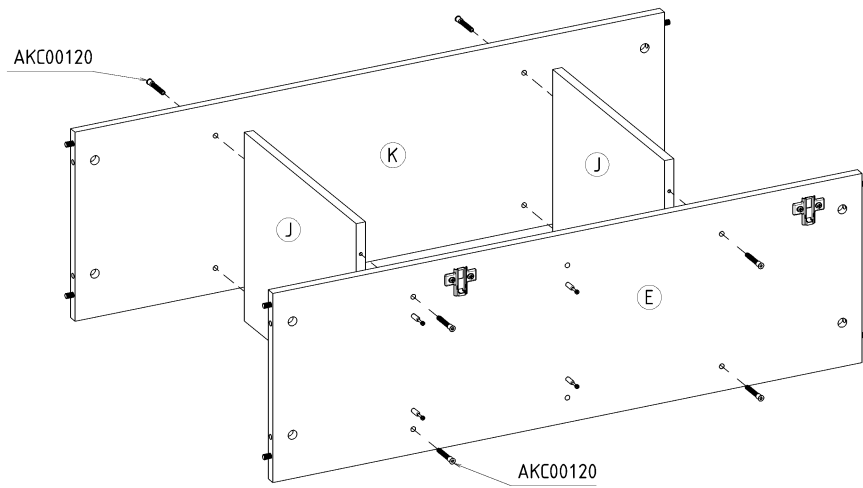

6

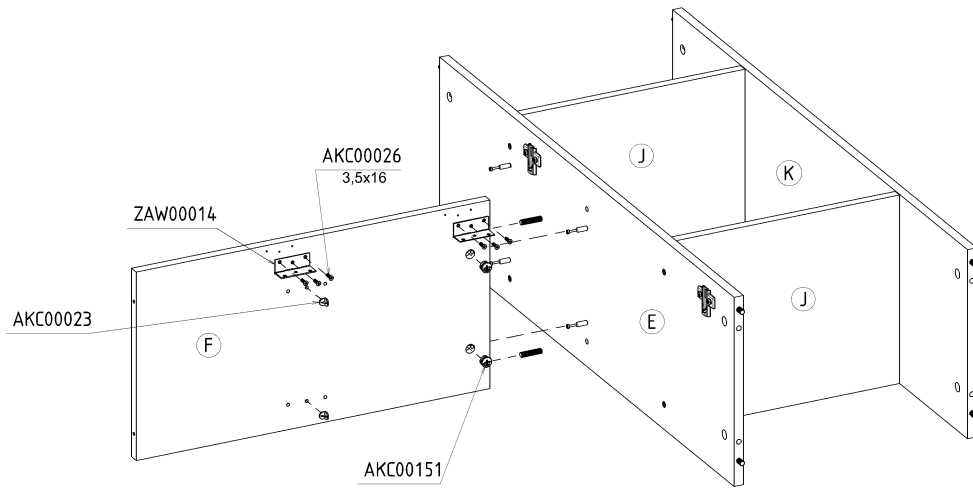

7

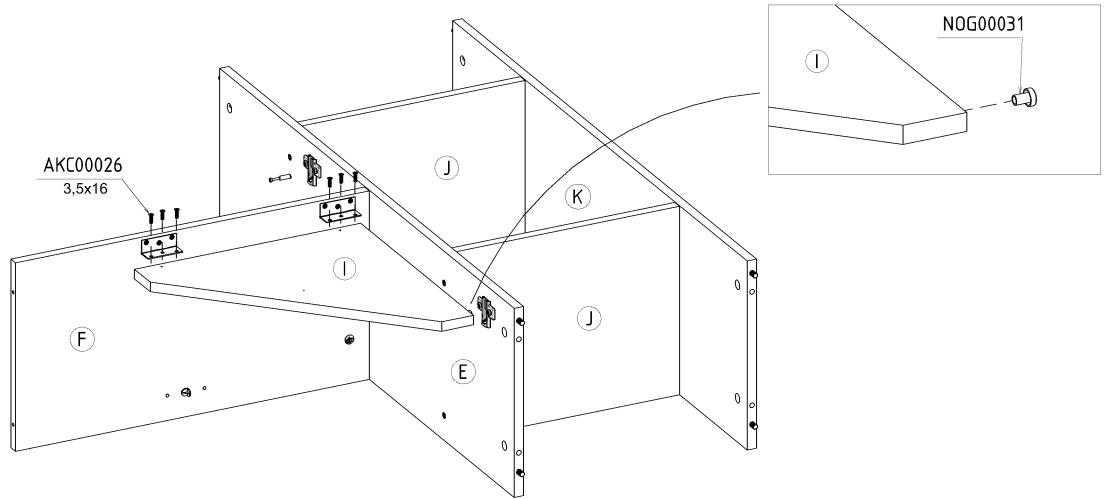

8

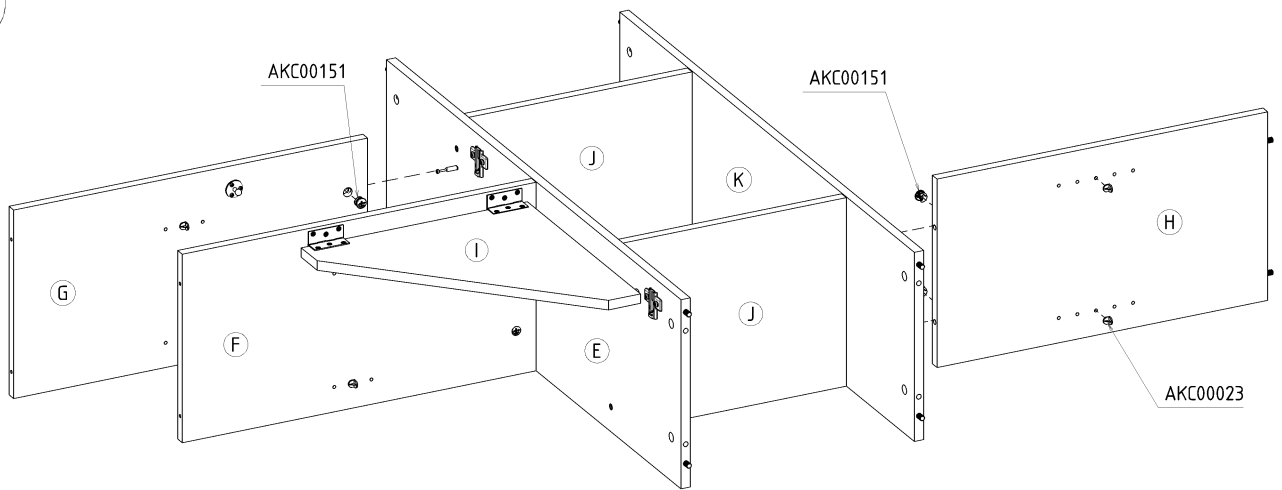

9

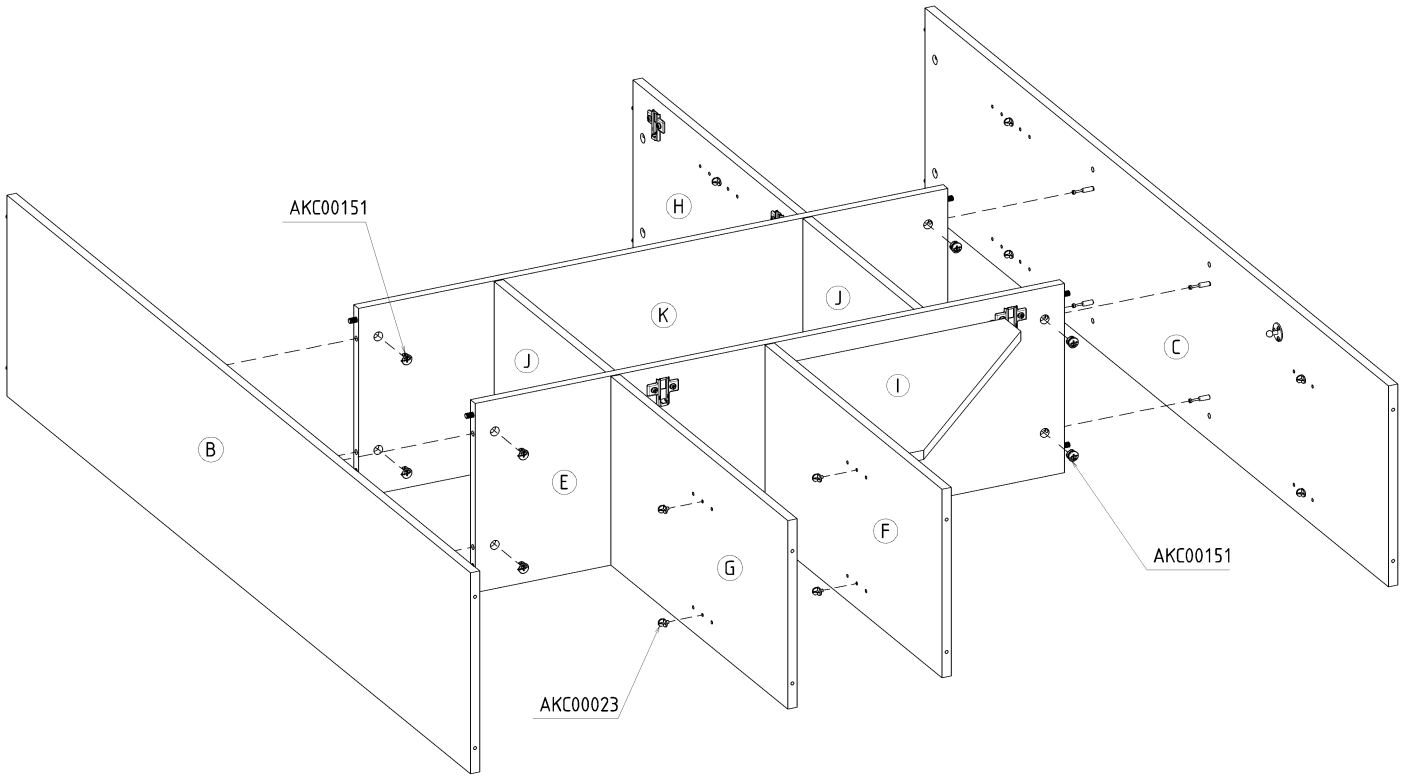

10

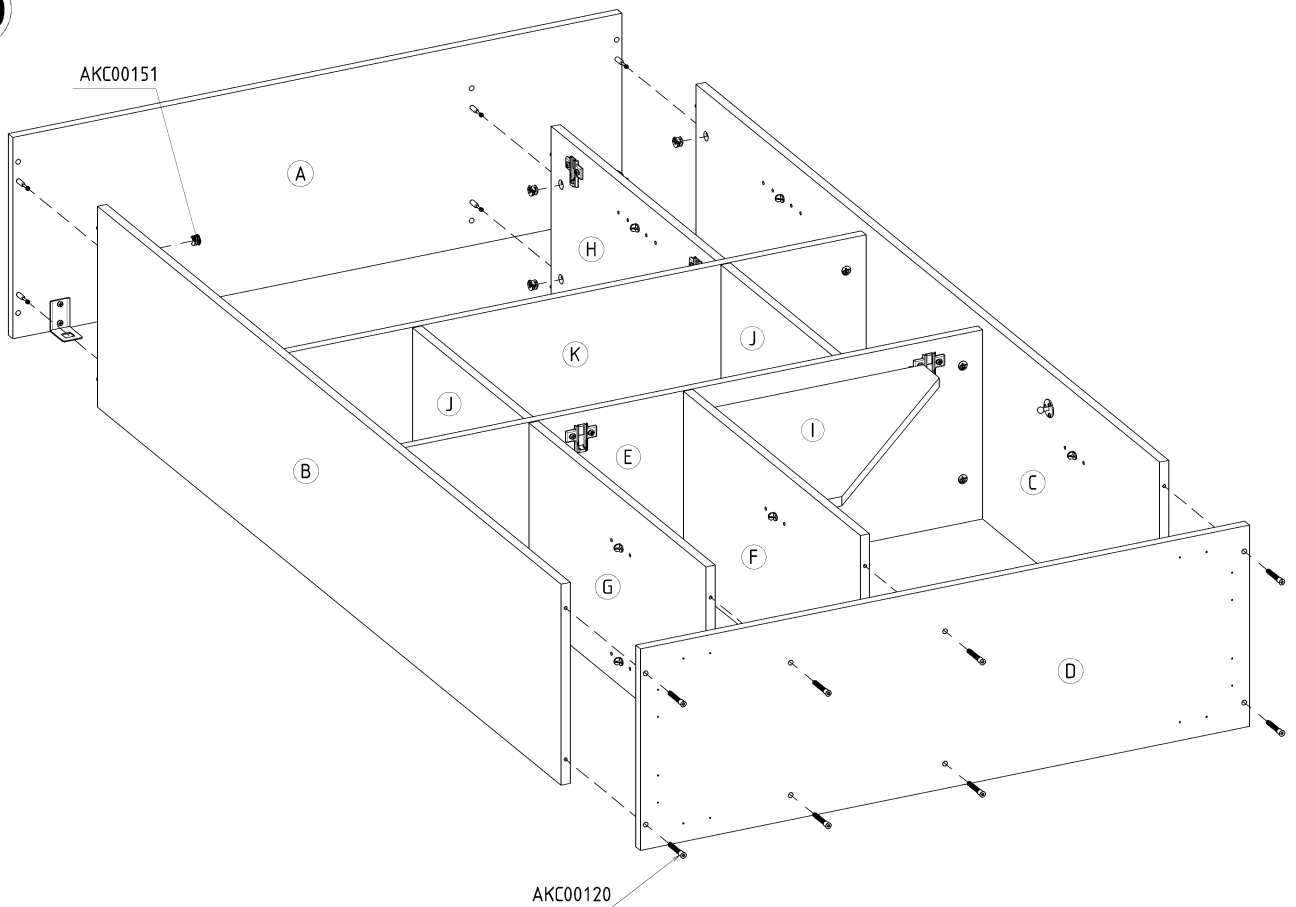

11

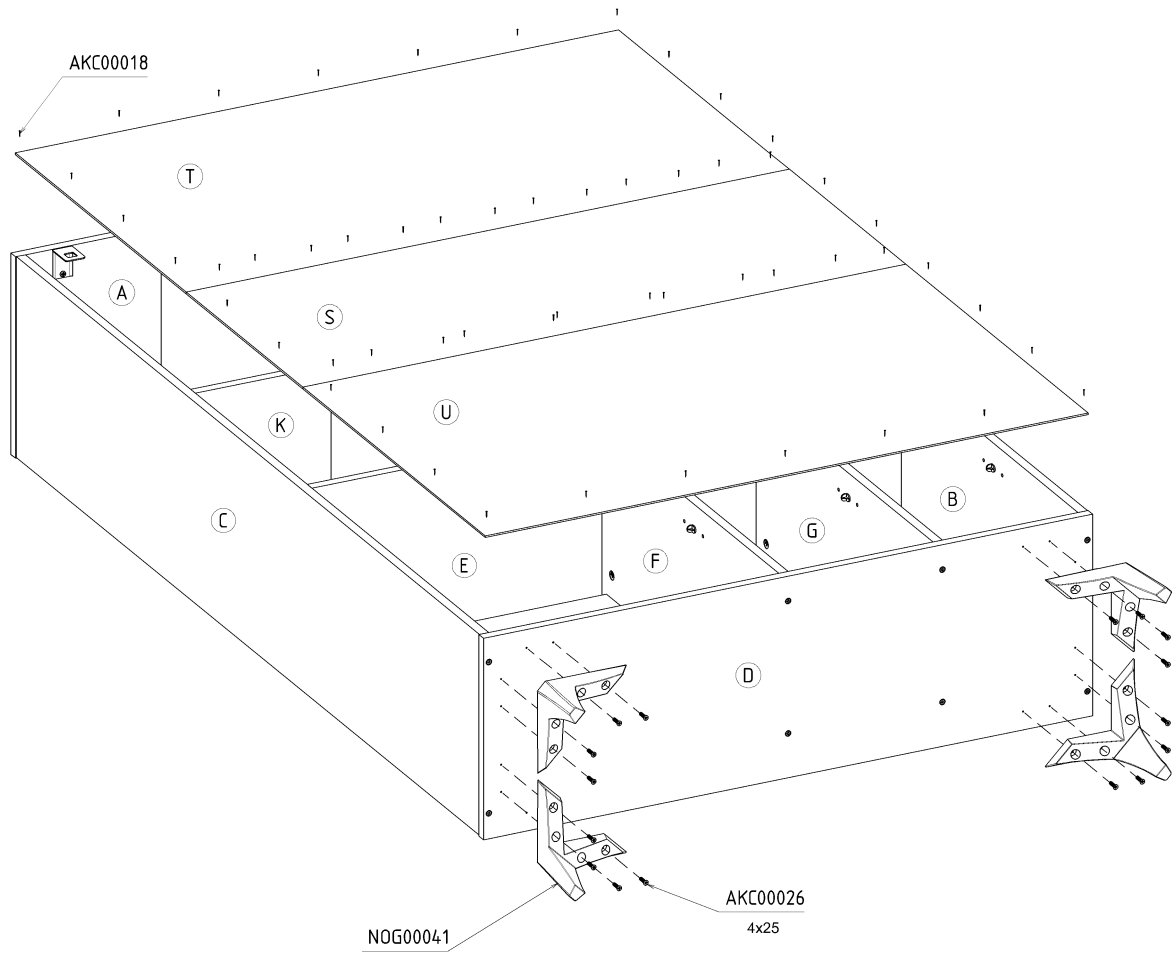

12

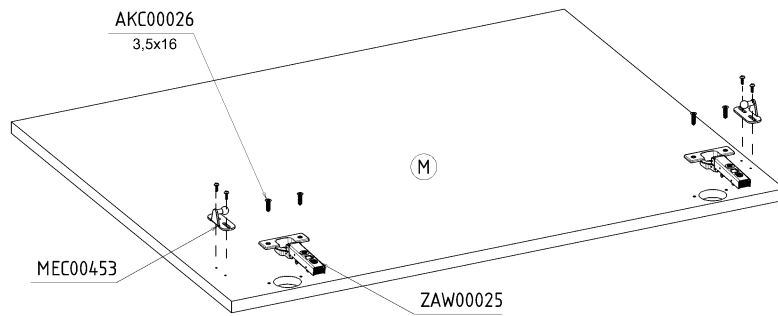

13

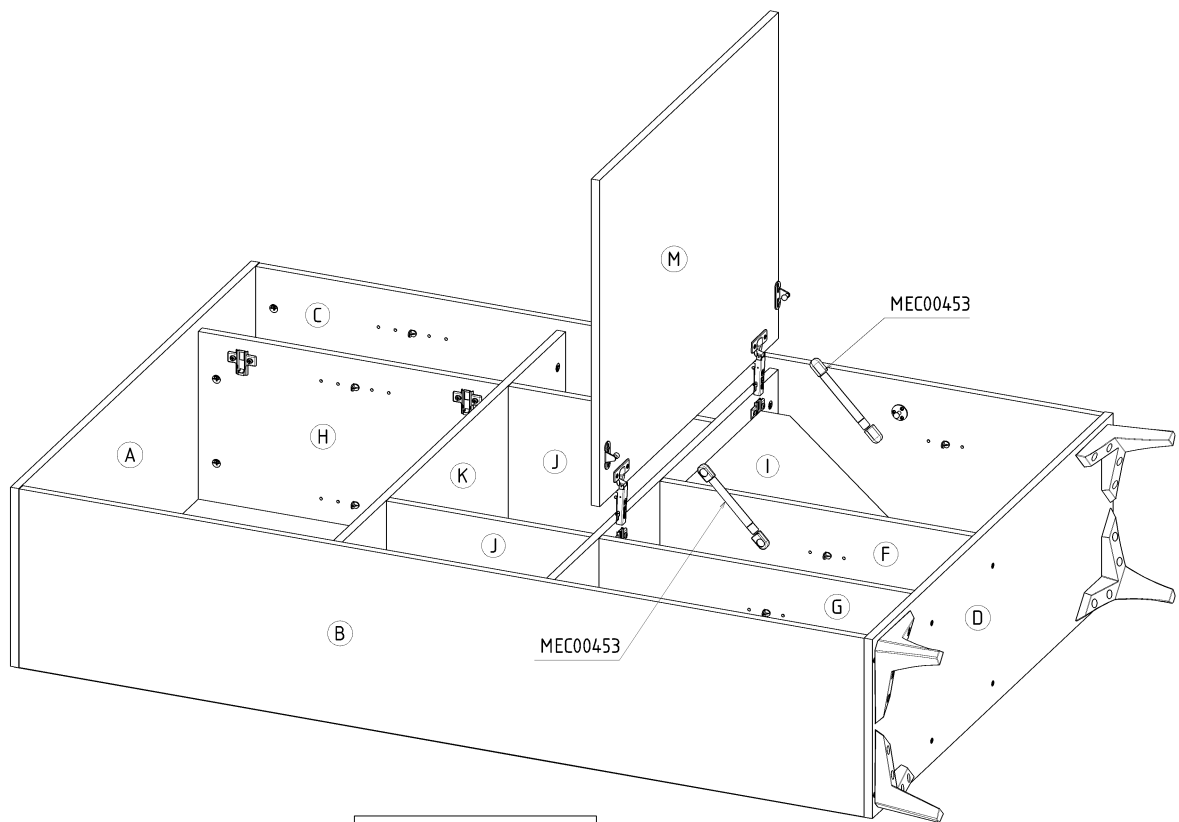

14

