

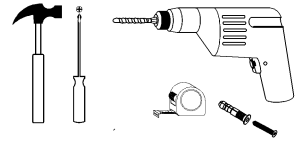

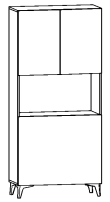







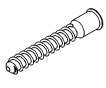

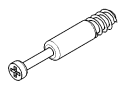

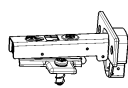

Megan 1

L-80 H-175 D-36/99

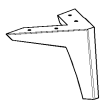

60 min

<p>x 14</p>  <p>AKC00019</p>	<p>x 6</p>  <p>AKC00120</p>	<p>x 6</p>  <p>AKC00004</p>	<p>x 14</p>  <p>AKC00029</p>	<p>x 14</p>  <p>AKC00151</p>	<p>x 14</p>  <p>AKC00004</p>
<p>x 6</p>  <p>ZAW00025</p>	<p>x 12</p>  <p>AKC00023</p>	<p>x 1</p>  <p>NOG00031</p>	<p>x 2</p>  <p>ZAW00014</p>	<p>x 2</p>  <p>AKC00066</p>	<p>x 60</p>  <p>AKC00018</p>
<p>x 4</p>  <p>6,2x13 AKC00031</p>	<p>x 24</p>  <p>3,5x16 AKC00026</p>	<p>x 16</p>  <p>4x25 AKC00026</p>	<p>x 1</p>  <p>AKC00017</p>	<p>x 2 N-120</p>  <p>MEC00453</p>	<p>x 4</p>  <p>NOG00041</p>

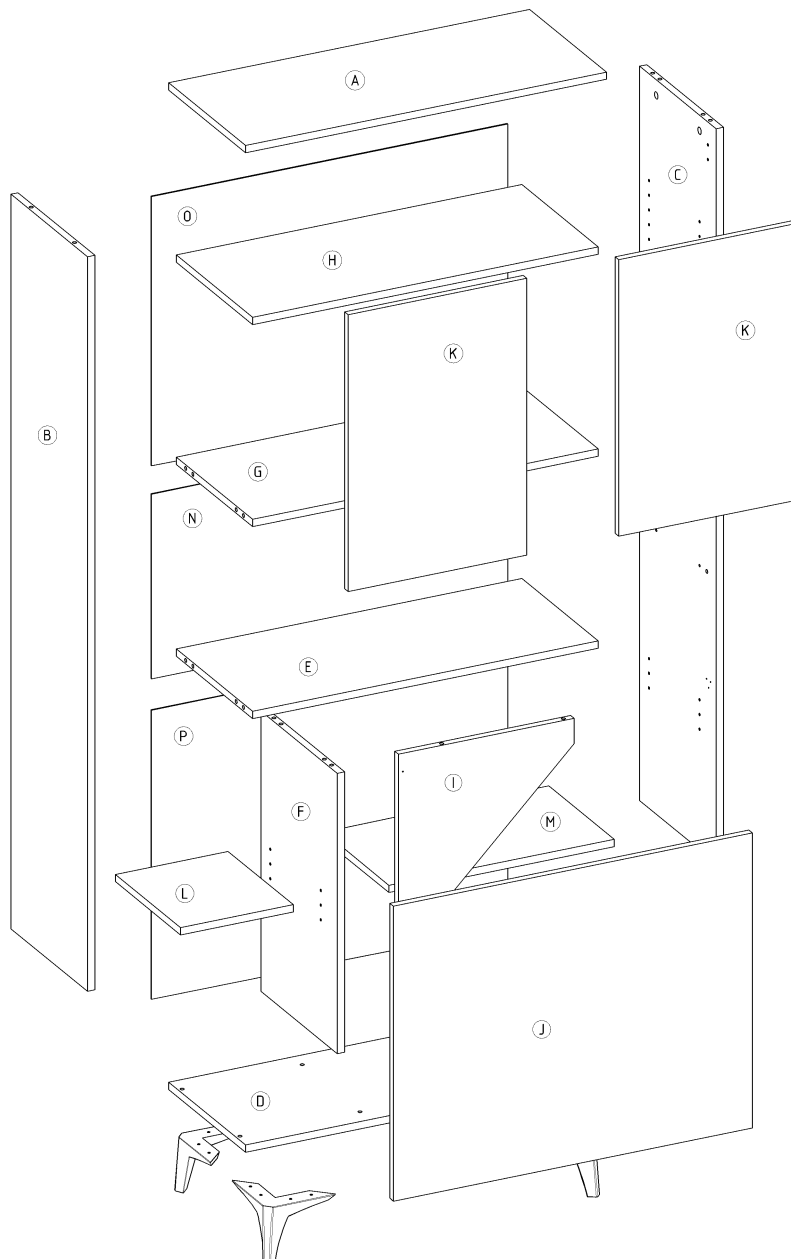

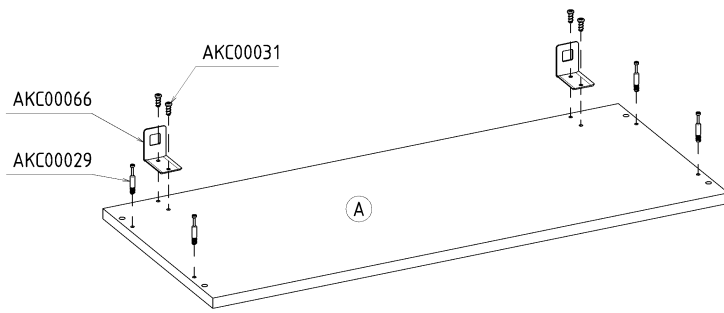
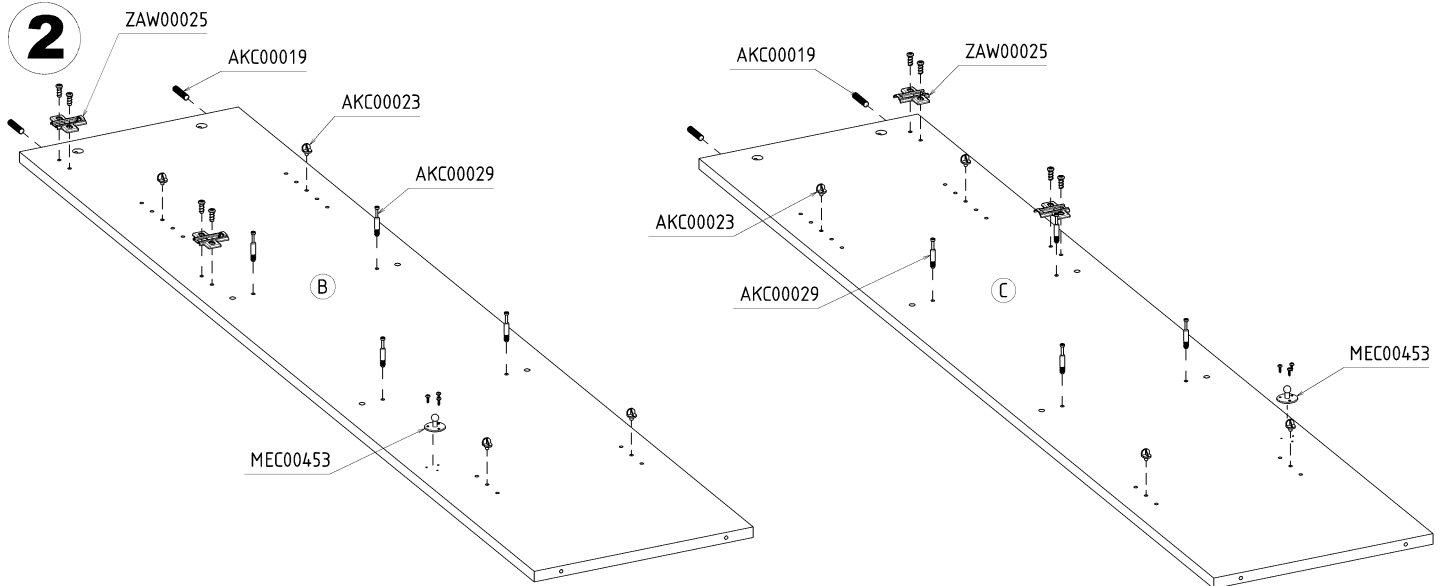
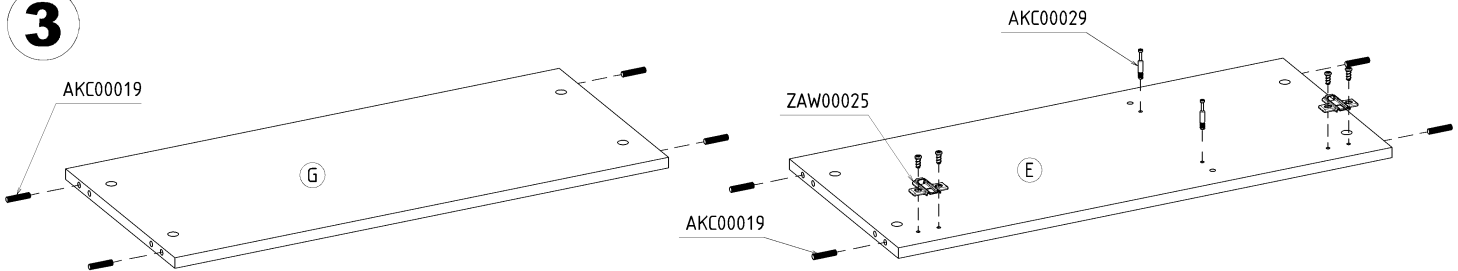
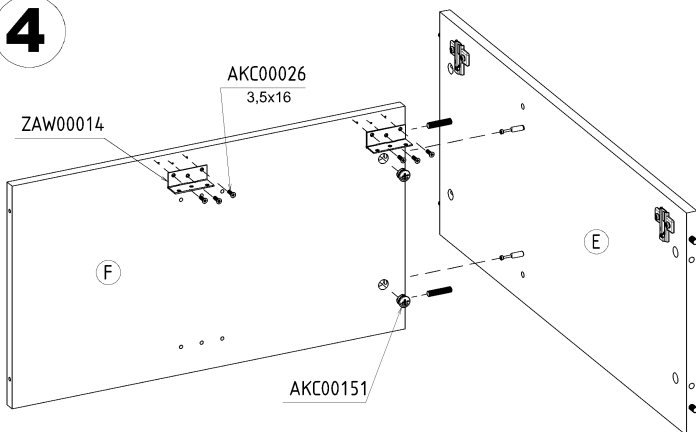
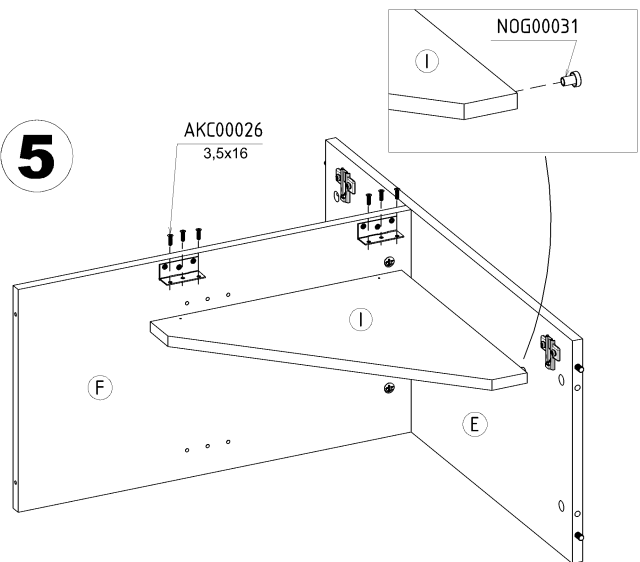
1**2****3****4****5**

6

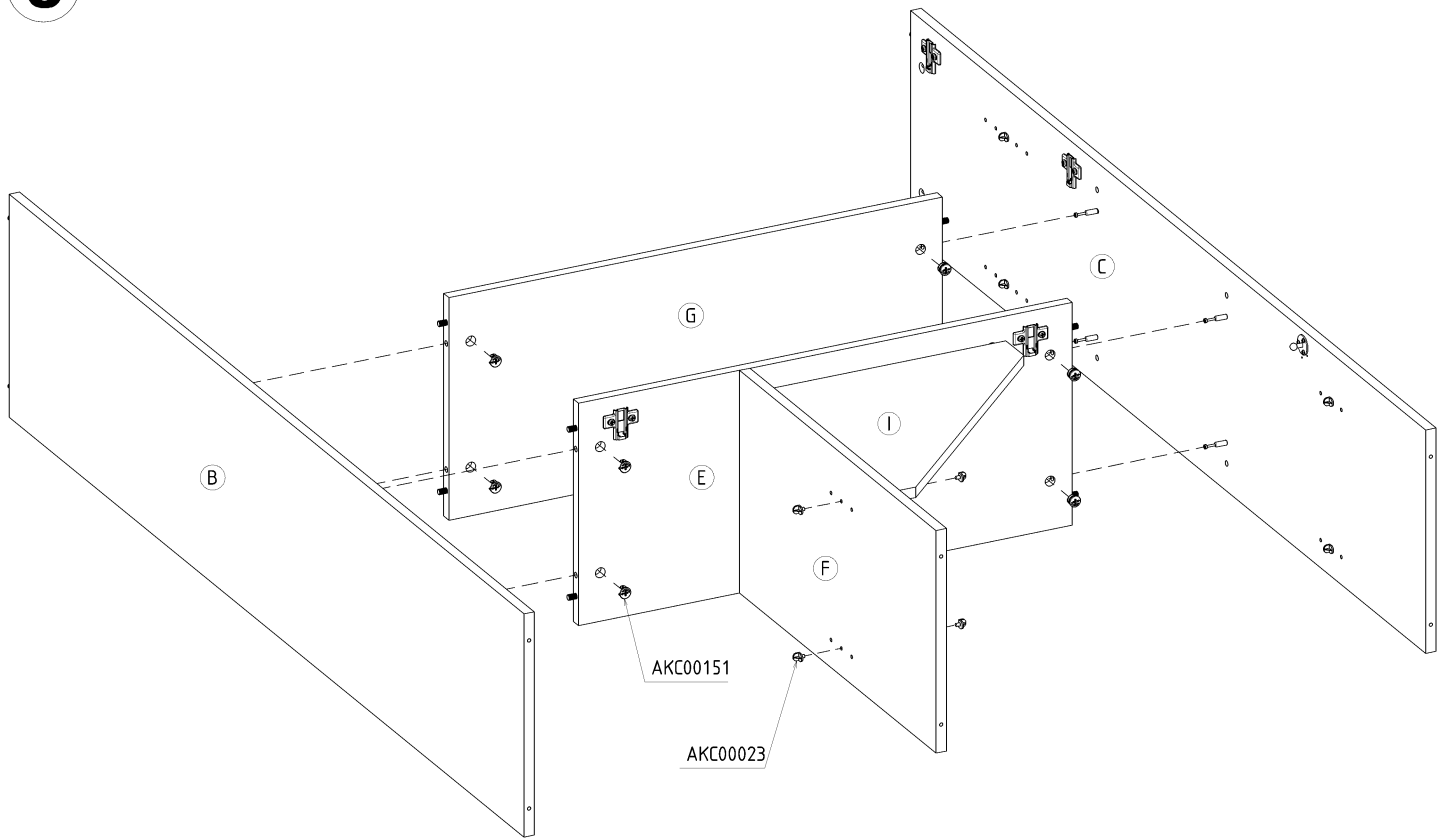

7

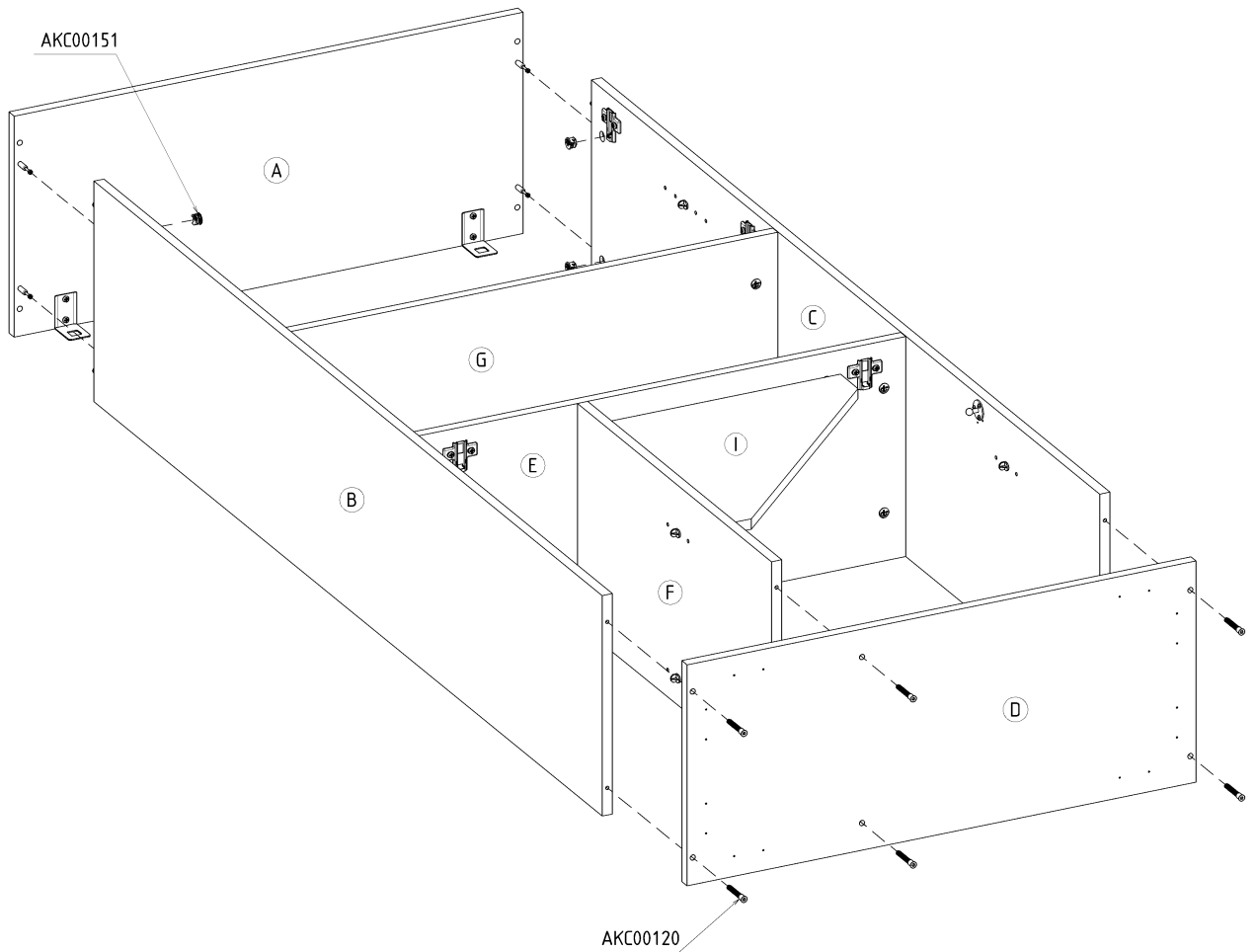

8

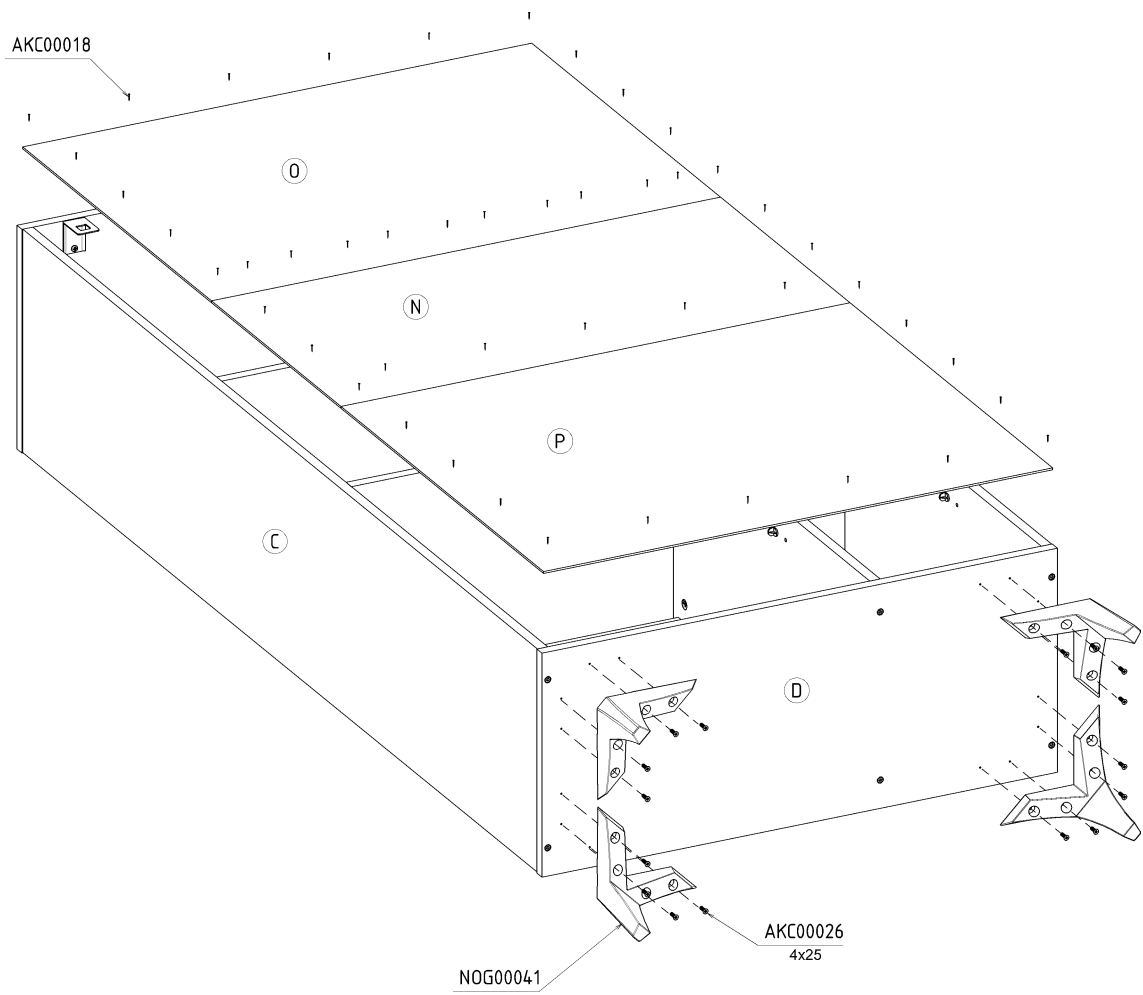

9

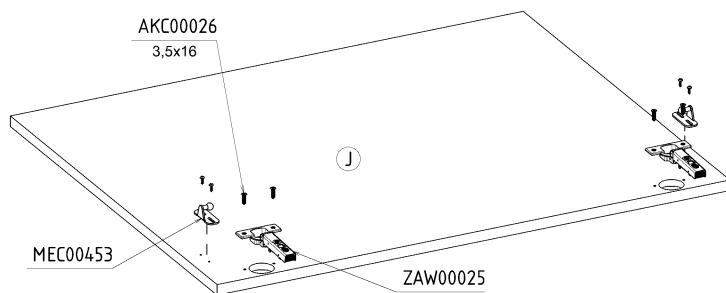

10

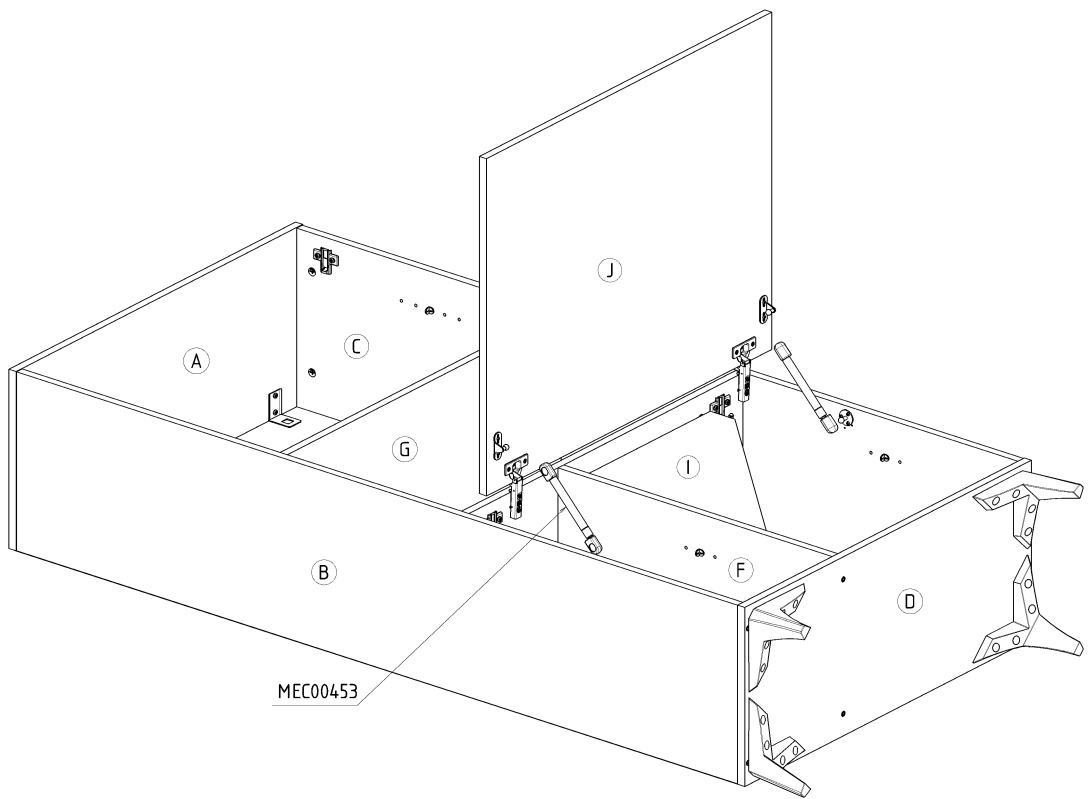

11

